



10'x10' INSTANT SHELTER® CANOPY

(3.0m x 3.0m)

INSTRUCTION SHEET

Includes: (1) 10' PATRIOT™ Frame, (1) Water-Resistant Fabric Top, (1) Vented Top, (1) 4-Piece Spike Kit, (1) Trax™ Roller Bag



SET UP

1 OPENING THE SHELTER FRAME

- Place your E-Z UP® frame in the center of the area to be sheltered.
- Lift and partially pull the shelter frame apart.

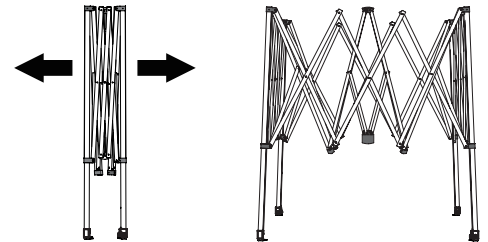

2 ATTACHING THE SHELTER TOP

- Place the vent top over the top part of the frame and slip the corners into the pockets.
- Unfold the fabric top and place on top of the frame.
- Secure the fabric top to the corners of the frame using the hook and loop connections.

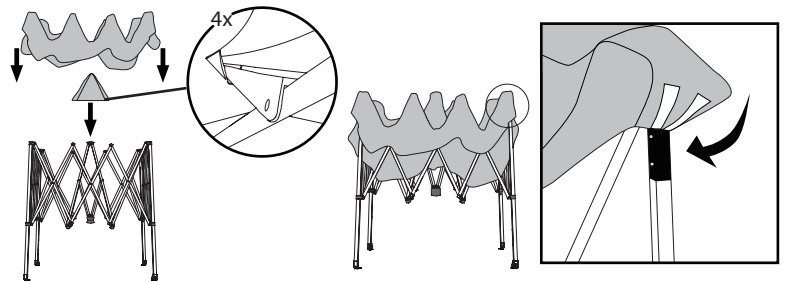

3 LOCKING THE FRAME

- From under the shelter, use one hand to push the ONE-UP™ hub straight up until it clicks into the pole.

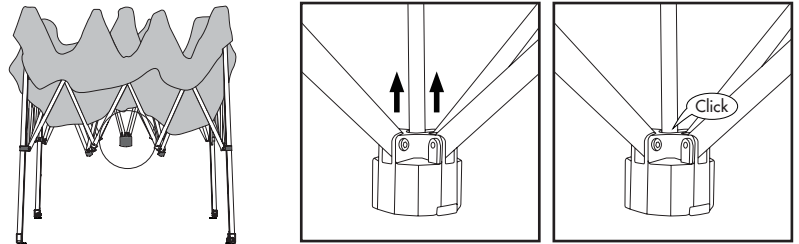

4 ADJUSTING THE SHELTER HEIGHT

- Finish securing the frame inside the shelter top using the hook and loop strips.
- Press the toggle adjustment on each leg and raise or lower to adjust the shelter height.

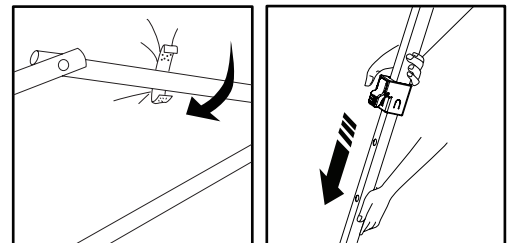
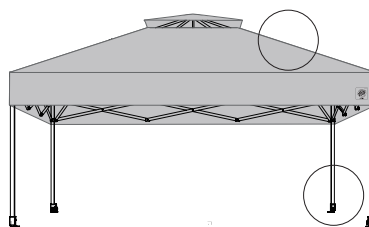

5 SECURING THE SHELTER IN PLACE

- Insert the supplied stake into the foot of each shelter leg.

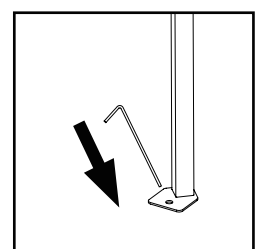

TAKEDOWN

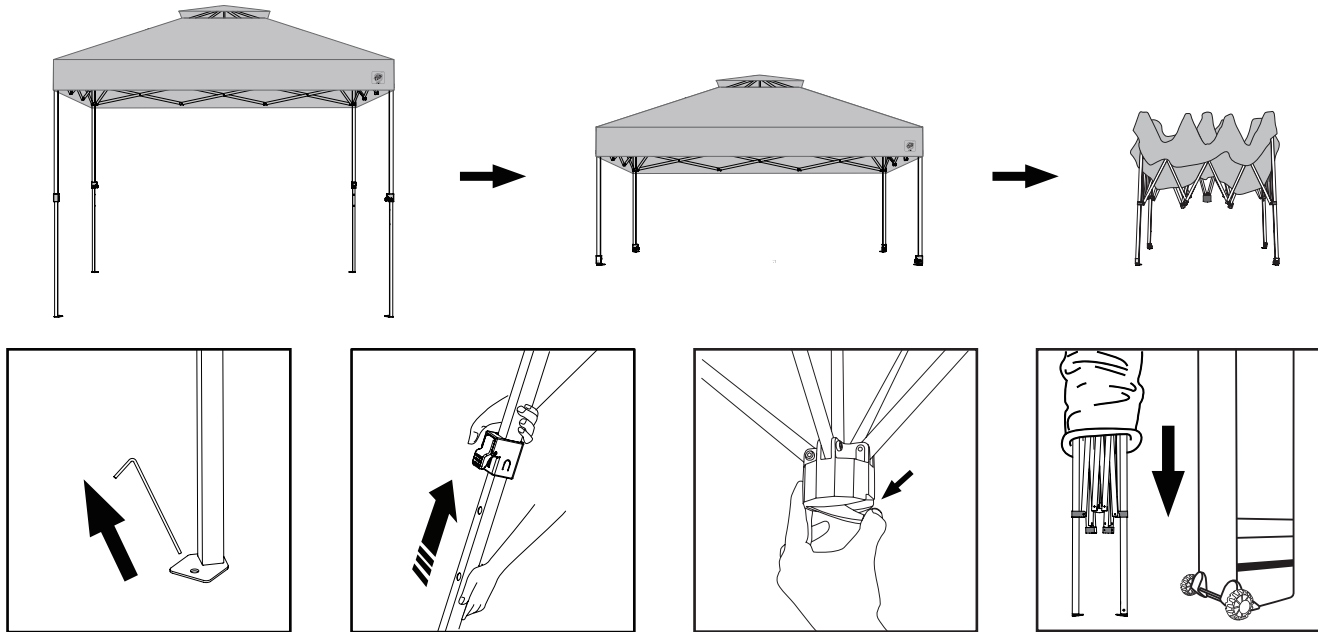

- Pull up all stakes from the ground. Press the toggle adjustment on each leg and retract the legs to their original height.
- Position yourself underneath the shelter, pull the tab on the ONE-UP™ hub to unlock the frame.
- Lift one corner of the frame until all legs are raised off the ground except for the one leg on the opposite corner. Push inward until the frame is fully closed.
- Slide the wheeled storage bag over the closed shelter.

CARE AND MAINTENANCE

For long lasting durability and the best possible protection for your E-Z UP® Instant Shelter® products, follow these E-Z care and maintenance instructions:

- Use a mild soap (not detergent) and plenty of water for top cleaning.
- Let the E-Z UP® top and frame dry completely before closing or storing to avoid mildew.
- Frame will operate and look better if occasionally wiped with silicone spray, especially before and after use in damp conditions. Remove excess silicone residue before applying top.
- Use a seam sealer if top leaks or drips water. Available at most sporting goods and hardware stores.
- Slightly tighten bolts if frame becomes loose.

Replacement Parts

For all shelter sizes: Call 800-45-SHADE or go to ezup.com/parts

WARNING: Keep all flame and heat sources away from all shelter fabrics. These fabrics meet the flammability requirements of CPAI-84. The fabric may burn if left in continuous contact with any flame source. The application of any foreign substance to the fabric may render the flame-resistant properties ineffective. NFPA-701 Certified.